











## DE VILLE

HOOR VISION OMEGA CO-AXIAL 41 MM

Steel on leather strap

Caliber  
8500

431.33.41.21.01.001

-  Co-Axial escapement
-  Si14 silicon balance spring
-  Automatic
-  Chronometer
-  Time zone function
-  Sapphire crystal
-  Anti-reflective treatment on both sides
-  Sapphire crystal case back
-  Water-Resistant to a relative pressure of 10 bar (100 metres/330 feet)



## WATCH FUNCTIONS

The crown has 3 positions:

**1. Normal position (wearing position):** when the crown is positioned against the case, the crown ensures that the watch is water-resistant.

**Occasional winding:** if the watch has not been worn for 60 hours or more, wind it up with the crown in position 1.

**2. Setting the time zone and correcting the date:** pull the crown out to position 2. Turn the crown forwards or backwards, and the hour hand will move forwards or backwards by 1-hour intervals. By passing the hour hand over midnight, the date can be changed forwards or backwards. Push the crown back to position 1.

*NB: when changing the time zone backwards, it is necessary to move the hour hand back past 7 pm to ensure the date changes.*

**3. Time setting:** hours – minutes – seconds. Pull the crown out to position 3. The seconds hand will stop. Turn the crown forwards or backwards. Synchronise the seconds by pushing the crown back to position 1 to coincide with a given time signal.

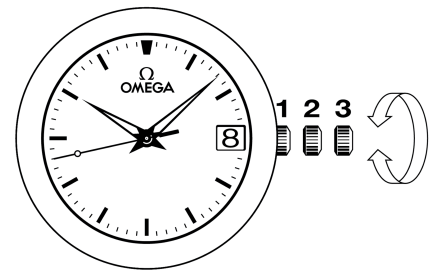

## FOLDOVER CLASPS

**Opening (fig. 1):** to open the clasp, press the two pushers on either side of the OMEGA buckle and pull upwards.

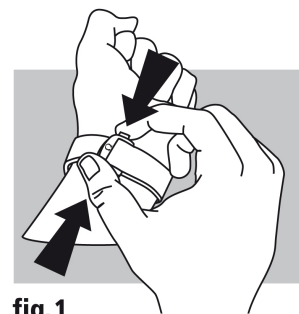

fig.1

**Closing (fig. 2):** put the watch on your wrist and close the clasp by pushing on it with your thumb until you hear a click. (fig. 2).

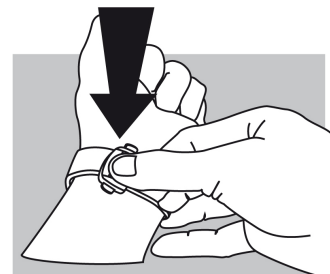

fig.2

**Adjusting the length (fig. 3):** free the longer section from the two slideways (A) and from the catch (B). Adjust the bracelet in the required direction and reinsert in the catch and the two slideways. Try the watch for size and readjust if necessary.

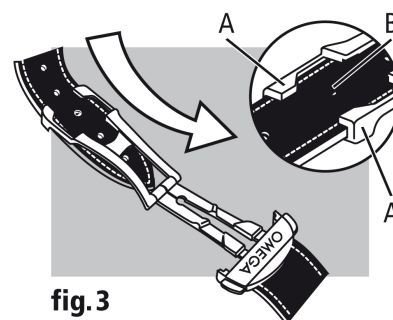

fig.3