















SEAMASTER

PLANET OCEAN 600M OMEGA CO-AXIAL 37.5 MM

Red gold on leather strap

Caliber
8521

232.63.38.20.01.001

-  Ceramic bezel
-  Co-Axial escapement
-  Si14 silicon balance spring
-  Automatic
-  Chronometer
-  Sapphire crystal
-  Anti-reflective treatment on both sides
-  Sapphire crystal case back
-  Screw-in crown
-  Helium escape valve
-  Gold 750‰ (18K)
-  OMEGA CERAGOLD™
-  Water-Resistant to a relative pressure of 60 bar (600 metres/2000 feet)



WATCH FUNCTIONS

The crown has 3 positions:

1. Normal position (wearing position): when the crown is positioned against the case, the crown ensures that the watch is water-resistant.

Occasional winding: if the watch has not been worn for 50 hours or more, wind it up with the crown in position 1.

2. Correcting the date: pull the crown out to position 2, turn the crown forwards, then push the crown back to position 1.

NB: date-setting is not recommended between 8 pm and 2 am.

3. Time setting: hours – minutes – seconds. Pull the crown out to position 3. The seconds hand will stop. Turn the crown forwards or backwards. Synchronise the seconds by pushing the crown back to position 1 to coincide with a given time signal.

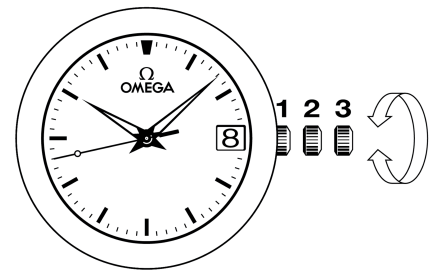

HELIUM ESCAPE VALVE

How to use the helium escape valve? (fig. 2)

In its normal position (fig. 2.1), the OMEGA helium escape valve is perfectly watertight thanks to the gaskets (B), but it is not functional, since it is screwed down.

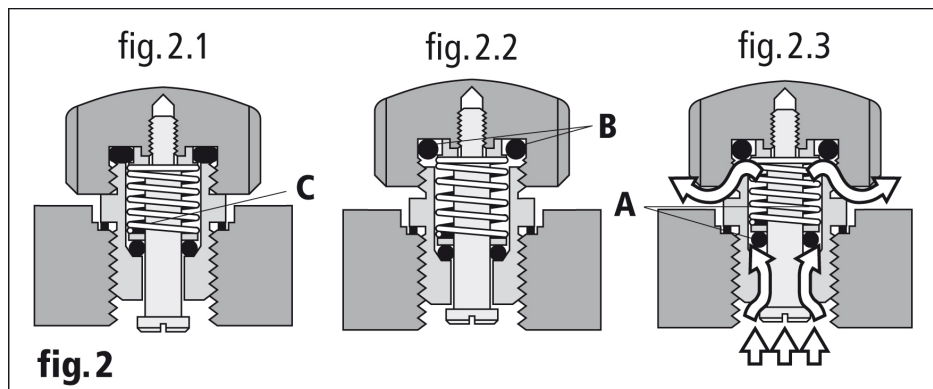

During the decompression phase, unscrew the crown of the valve in order to release the mechanism (fig. 2.2). The valve is now watertight from the outside. As the interior pressure becomes greater than the exterior pressure, it pushes the gasket (A) out of its seating, thus releasing the gas (fig. 2.3). Once the pressure is equalised, gasket (A) returns to its original position, pushed by the spring (C) (fig. 2.2).

This operation is automatically repeated several times during the decompression phase. Once atmospheric pressure is reached, screw down the crown of the valve (fig. 2.1).

Note: Even if the valve is unscrewed, and we strongly recommend that the valve remains screwed down whenever the watch is immersed in water, the watch is still water-resistant to a relative pressure of 5 Bar (50 metres). However, complete water-resistance to the dial depth can only be achieved with gasket (B) and the valve in the screwed down position.

FOLDOVER CLASPS

Opening (fig. 1): to open the clasp, press the two pushers on either side of the OMEGA buckle and pull upwards.

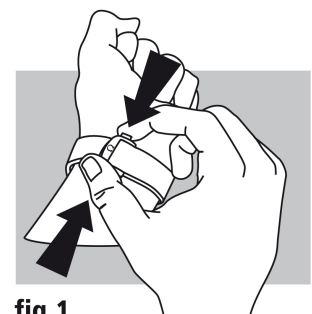

Closing (fig. 2): put the watch on your wrist and close the clasp by pushing on it with your thumb until you hear a click. (fig. 2).

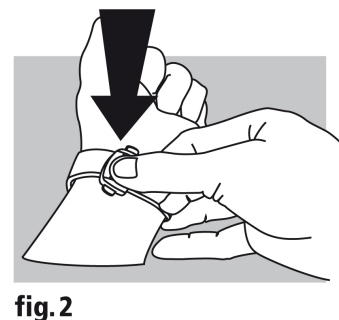

Adjusting the length (fig. 3): free the longer section from the two slideways (A) and from the catch (B). Adjust the bracelet in the required direction and reinsert in the catch and the two slideways. Try the watch for size and readjust if necessary.

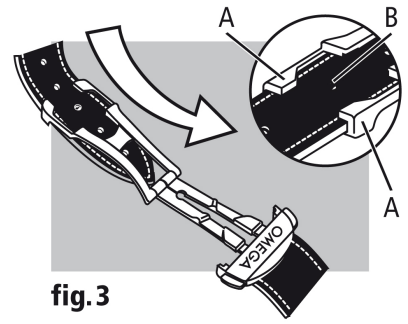

fig. 3