















SEAMASTER

AQUA TERRA 150 M OMEGA CO-AXIAL 34 MM

Steel - red gold on leather strap

Caliber
8520

231.28.34.20.55.002

-  Co-Axial escapement
-  Si14 silicon balance spring
-  Automatic
-  Chronometer
-  Sapphire crystal
-  Anti-reflective treatment on both sides
-  Sapphire crystal case back
-  Screw-in crown
-  Gold 750‰ (18K)
-  Watch with diamond(s)
-  4-year International Warranty
-  Water-Resistant to a relative pressure of 15 bar (150 metres/500 feet)



WATCH FUNCTIONS

The crown has 3 positions:

1. Normal position (wearing position): when the crown is positioned against the case, the crown ensures that the watch is water-resistant.

Occasional winding: if the watch has not been worn for 50 hours or more, wind it up with the crown in position 1.

2. Correcting the date: pull the crown out to position 2, turn the crown forwards, then push the crown back to position 1.

NB: date-setting is not recommended between 8 pm and 2 am.

3. Time setting: hours – minutes – seconds. Pull the crown out to position 3. The seconds hand will stop. Turn the crown forwards or backwards. Synchronise the seconds by pushing the crown back to position 1 to coincide with a given time signal.

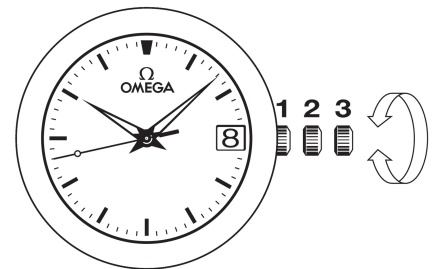

FOLDOVER CLASPS

Opening (fig. 1): to open the clasp, press the two pushers on either side of the OMEGA buckle and pull upwards.

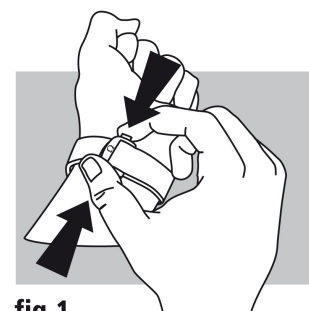

fig. 1

Closing (fig. 2): put the watch on your wrist and close the clasp by pushing on it with your thumb until you hear a click. (fig. 2).

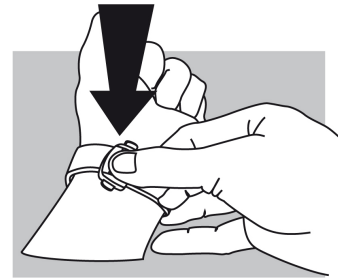

fig.2

Adjusting the length (fig. 3): free the longer section from the two slideways (A) and from the catch (B). Adjust the bracelet in the required direction and reinsert in the catch and the two slideways. Try the watch for size and readjust if necessary.

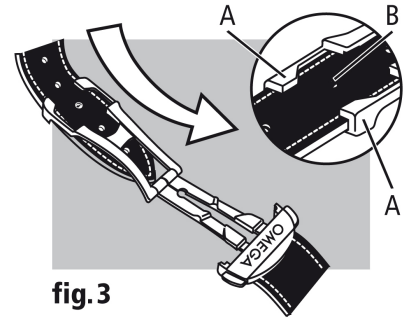

fig.3